

920 Radar Pulse Wave Level BLE Sensor Installation Guide [9415-B0001]

The 920 Pulse Wave Radar BLE sensor is a tank level liquid monitor for plastic or steel tanks. It can be installed invasively, that is looking directly into the contents of the tank, or non-invasively looking through the tank wall on plastic tanks. It transmits the data wirelessly through a proprietary BLE advertisement packet and has a local display.

This installation guide is divided into non-invasive (Page 1) and invasive installation – (Page 9).

Installation Instructions - NON-INVASIVE PLASTIC TANK MOUNTING

Please also refer to audio visual guides referenced in the appendix.

STEP 1: Sensor Location:

- Select a location on top of the tank that is not too close (<25cm) to any internal or external obstructions.
- The selected location should also be dry, level and clear from any standing water that could occur. Ensure that no water enters the base adapter during the installation.
- Please also see additional tank mounting guidelines in the Appendix.

STEP 2: Site Preparation:

- Clean the area where the adhesive pad is to be placed to remove any grease or dirt. This can be done with an alcohol rub or equivalent.



STEP 3: Mounting of the bayonet adapter:

- Turn the sensor upside down and place the black O-ring in position on the base of the Pulse Wave unit and push the adapter into position and hand tighten with the four M3 screws 10mm/0.4" with a Pozi /Phillips screwdriver. Ensure the bayonet adapter is firmly pressed against the base of the sensor.

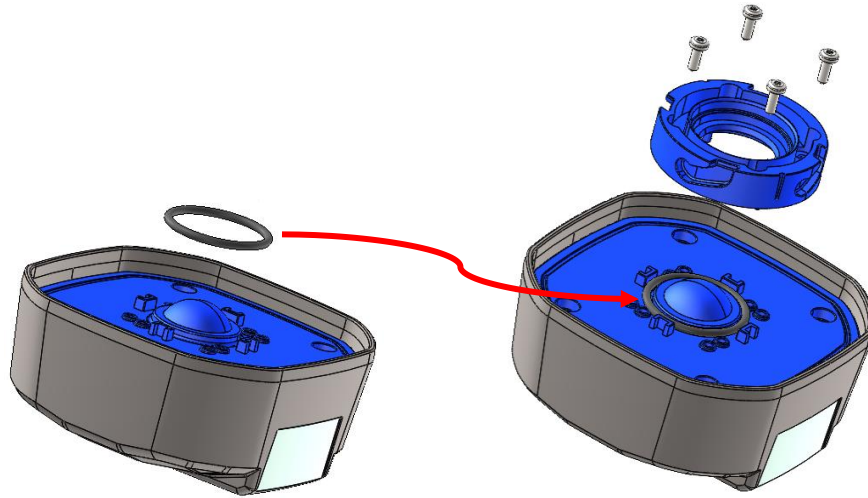

STEP 4: Wake-up:

- To activate the Bluetooth function and wake the sensor from factory mode – hold the sensor in a horizontal orientation and firmly double-tap the rear edge of the enclosure on a hard surface (see graphic below).
- The two taps should be applied within a 2 second window. This is referred to as a double-tap. This should be repeated two more times with a one second pause between double-taps.

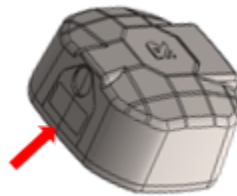

STEP 5: Base Adapter

- Insert the blue O-ring into the base adapter as shown.

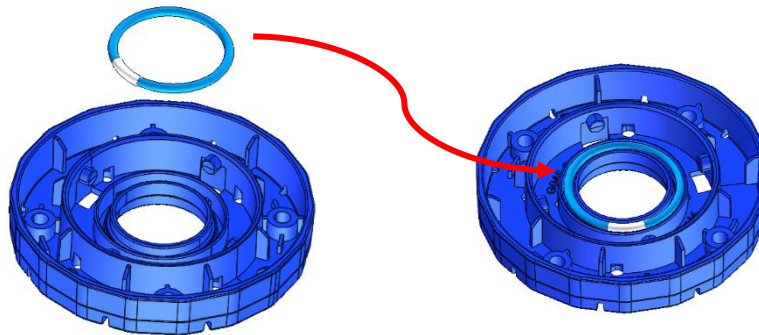

STEP 6: Assembling base adapter to sensor.

- Lock the sensor and base adapter together by firmly screwing in the bayonet adapter to the base.

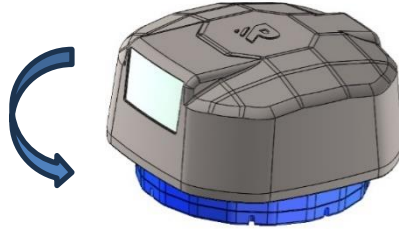

STEP 7: Adhesive pad:

- Remove the top protective tab on the adhesive pad and carefully adhere it to the base adapter.
- Ensure that it is centrally mounted and that the adapter and pad holes are aligned.

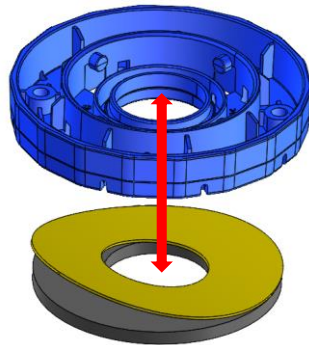

STEP 8: Open BLE App:

- Open the Rochester BLE cellphone app (ref: Rochester Universal BLE app quick start guide). Ensure BLE is enabled on the cellphone app (See Appendix for additional reference).
- Select the '920 Pulse Wave Radar' from the sensor menu.
- Press the **scan** button (*screen 1 – Page 4*) to display the list of sensors available.
Note: The Scan button changes to red and pulses while active.
- If the sensor does not appear on the BLE App Scan list. Perform the double-tap function again.

STEP 9: BLE Setup:

- Select sensor by serial number from list (*screen 1 – Page 4*).
- Screen 2 (adjacent) will pop up for the selected relevant sensor's serial number.
- Review section 1 – Site Prep for hints on sensor mounting preparation and location.
- Click the **install** button on screen 2 to start the installation sequence.

SCREEN 1

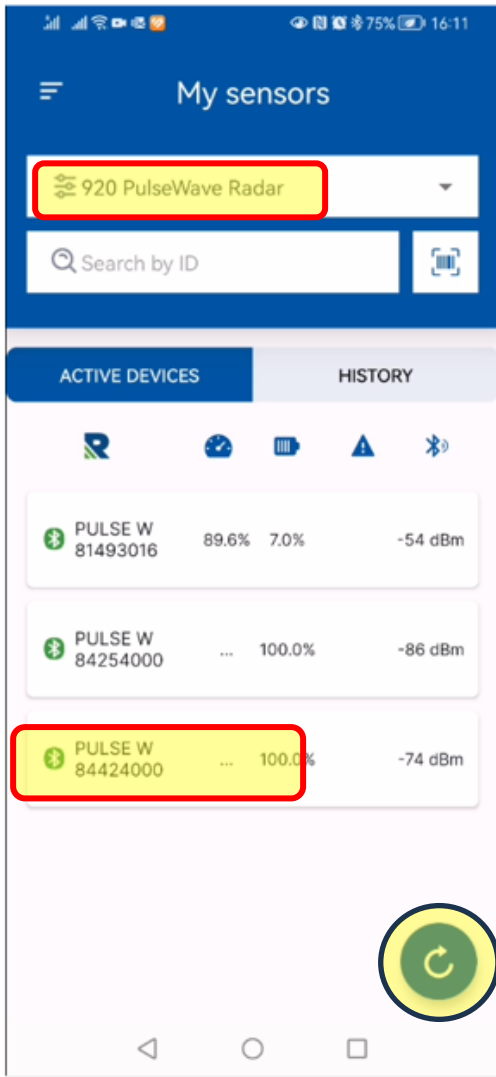

SCREEN 2

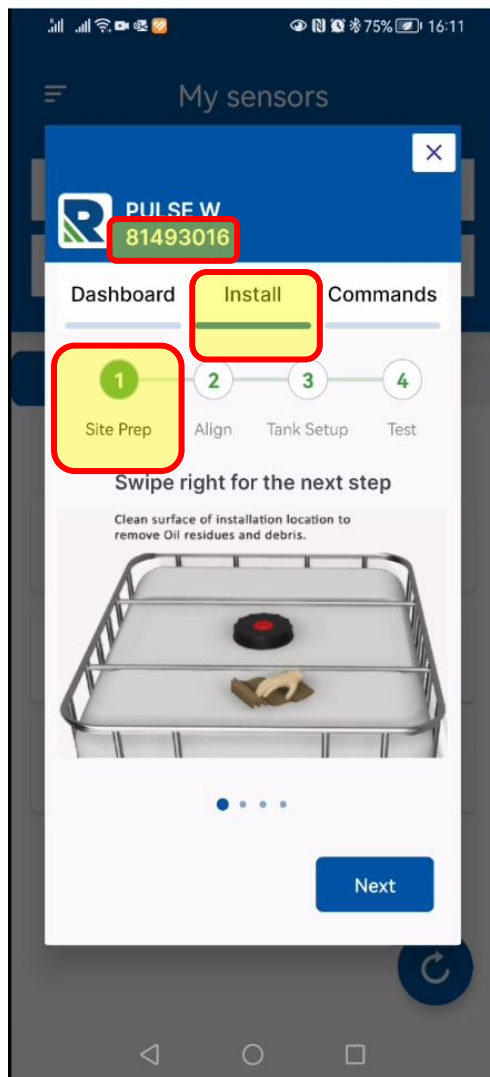

STEP 10: BLE Install - align:

- Press **Next** to move to section 2 – Align.
- If a **green** or **orange** dot is displayed, the sensor is correctly aligned.
- Press **Next** to continue.

- If a **red dot** appears, choose an alternate location that is level.

Note: Red dot indicates that the chosen mounting position is not sufficiently level to give an acceptable performance and the BLE app will not allow the installer to proceed to the next stage.

Note: For tanks heights greater than 2m – it is preferable to have a green dot.

Note: The maximum sensor ullage range is 3m.

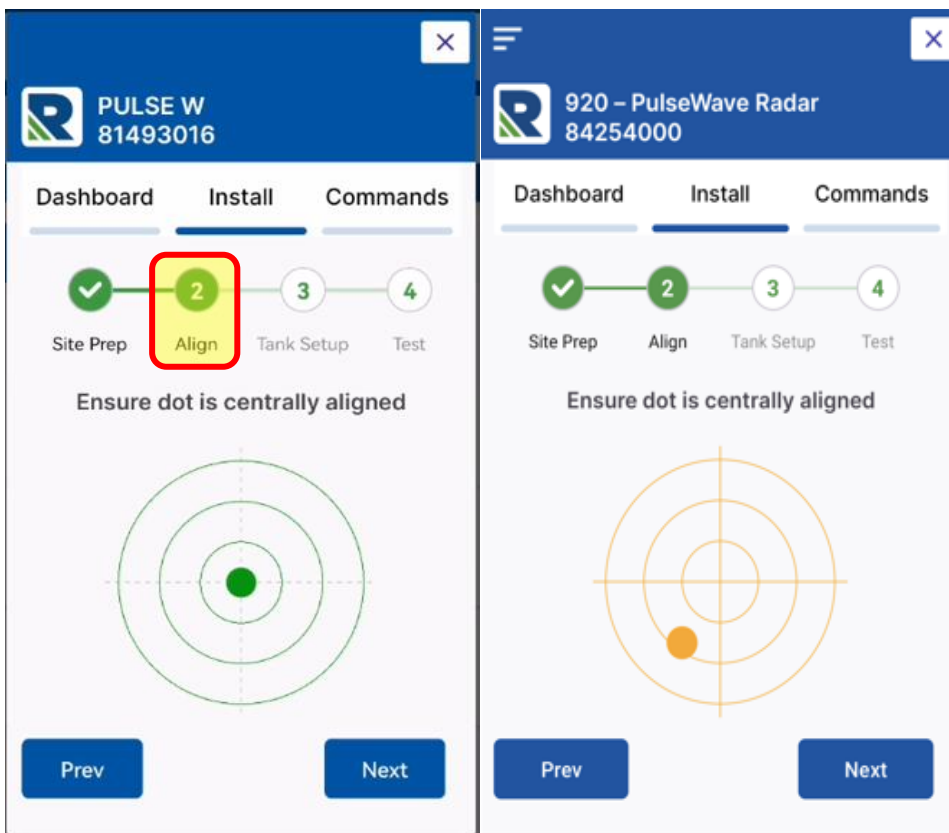

- Once this stage is complete, then the sensor may be fully installed in this area of the tank.

STEP 11: Mount sensor on tank.

- Remove the protective bottom tab on the adhesive pad and stick it to the tank (same location as previous test).

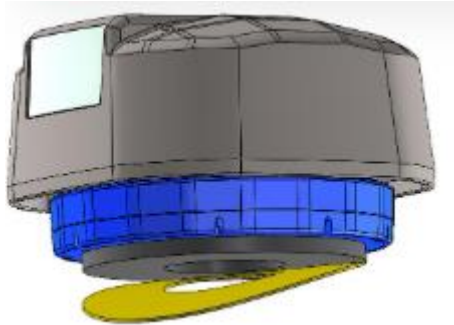

STEP 12: Sensor orientation.

- Orientate the unit to make the display (LCD) visible for user.
- Press firmly all over pad to adhere properly to the tank surface.

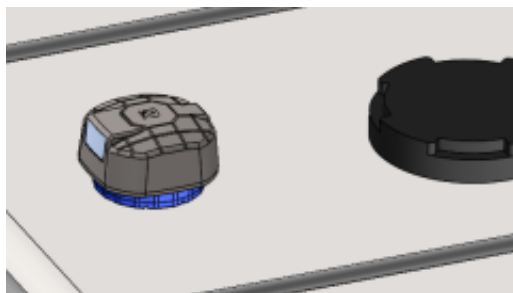

STEP 13: BLE Install - setup:

- Press **Next** to move to **Tank Setup** on section 3.

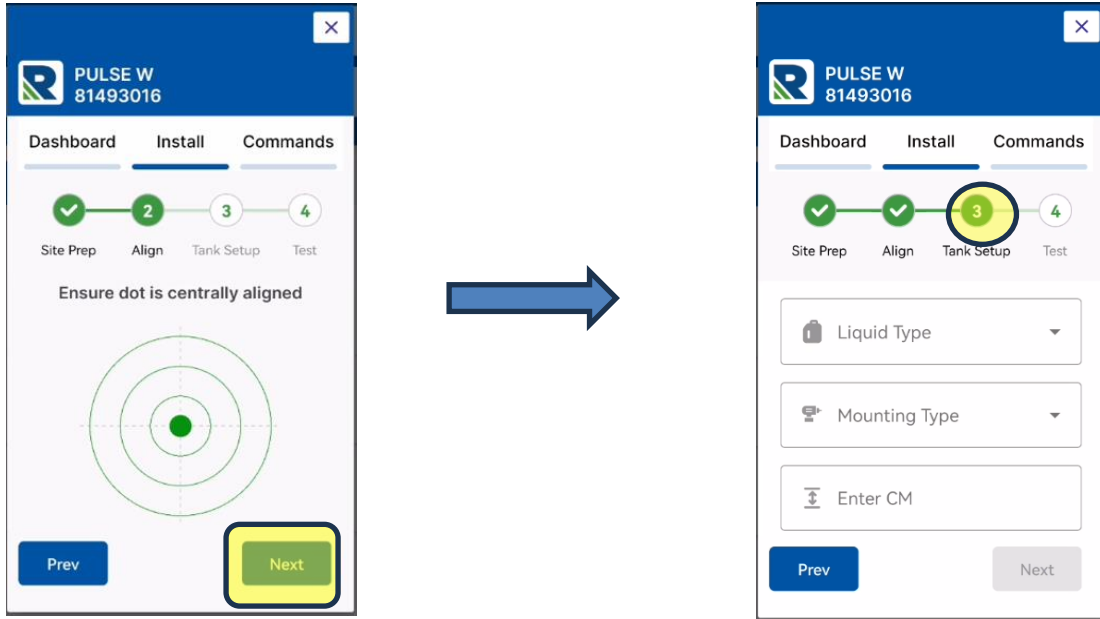

STEP 14: BLE Install - setup:

- On the dropdown menu – select the nearest liquid type: **Oil or Water**
- Select the correct *mounting option*: **Invasive or Non-Invasive**.
- Enter the usable **tank height in cm**. Refer to appendix for more details.

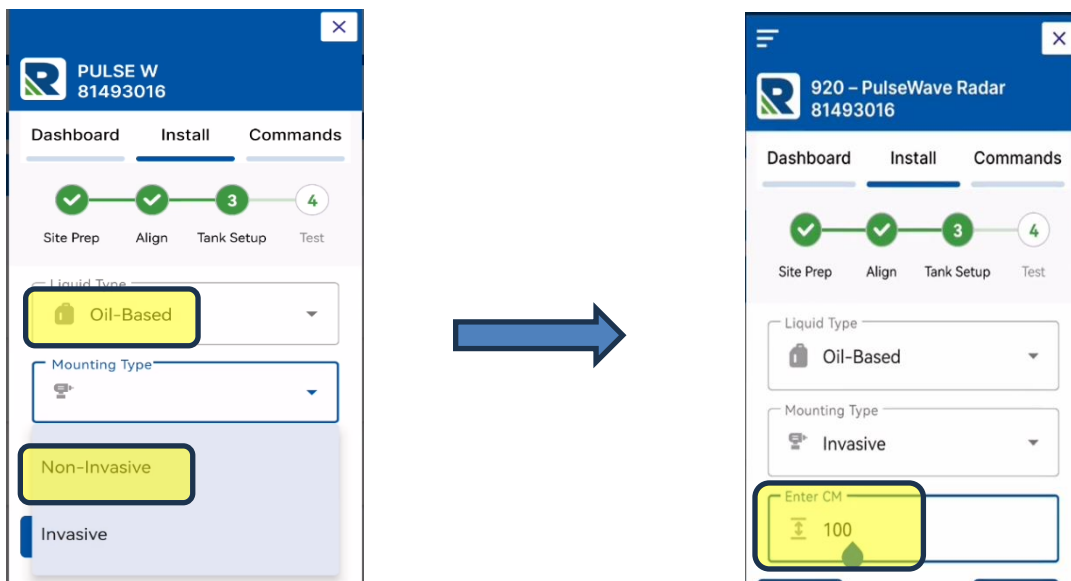

STEP 15: BLE Install - finish:

- Press **Next** to move to section 4 and wait for the test to complete and display **Installation Successful**.
- Press Finish to return to the Dashboard view.

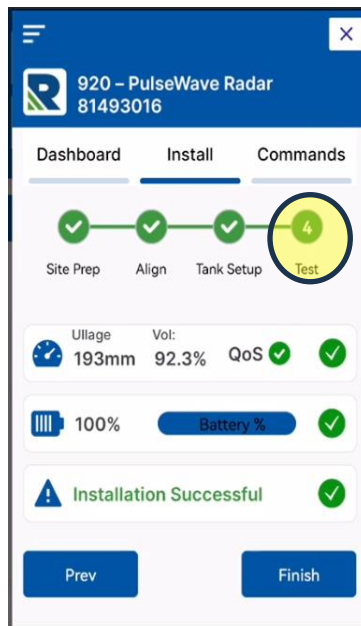

This concludes the installation.

STEP 15: Error in Install

- If the display indicates an **Installation Failed**.
- Check if the liquid type and tank height is correctly set, if not press the **Prev** button to go back and correct them.
- *In some circumstances the Installation can fail if there are issues with overfilled tanks where the sensor cannot resolve a correct reading in the blind zone. In the case of tank overfilled – it is recommended to either postpone installation or accept the current situation will resolve itself when the liquid level reduces.*

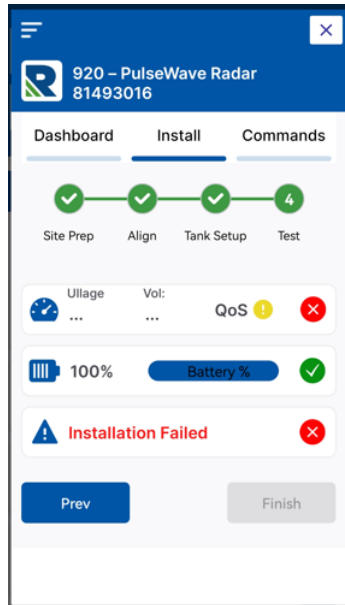

Installation Instructions - INVASIVE TANK MOUNTING

The invasive mounting arrangement for the 920 Pulse Wave is shown in the graphic below.

All the parts shown in the adjacent graphic are provided in the product packaging and it is mandatory to use these in the installation process.

Please also refer to audio visual guides referenced on the appendix.

STEP 1: Adapter assembly:

- Assemble the 1" NPT threaded adapter onto the base of the sensor as shown in the graphic below.

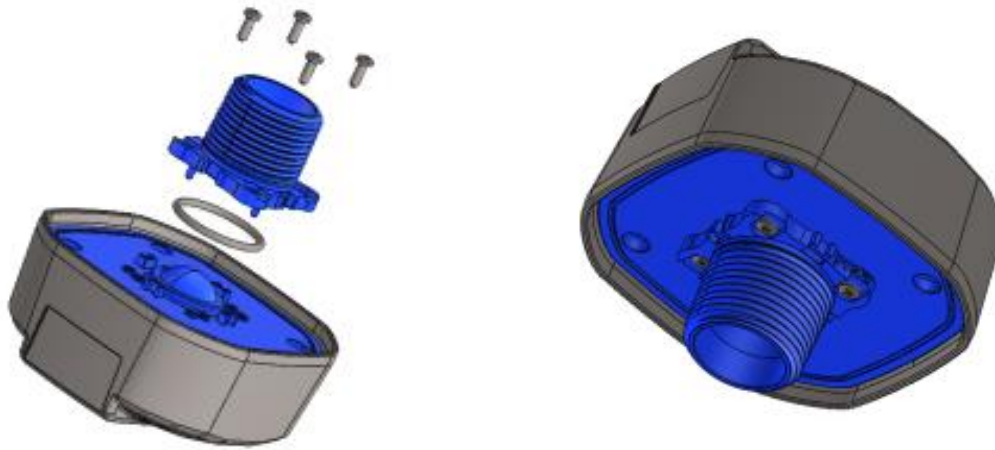

STEP 2:

- It is best practice to ensure a good seal by using 2 layers of nylon tape wound over the thread.

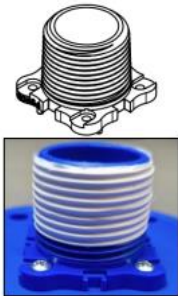

STEP 3: Tank Opening:

- Ensure that the threaded opening is smooth and clear of any obstacles. The threaded may be a 1" threaded adapter or 1" to 2" adapter for 2" (or bigger) openings.
- Screw the sensor into the tank opening and tighten – noting the LCD orientation.

STEP 4: Open BLE App:

- Open the Rochester BLE cellphone app (ref: Rochester Universal BLE app quick start guide). Ensure BLE is enabled on the cellphone app. (See Appendix for additional reference).
- Select the '920 Pulse Wave Radar' from the sensor menu.
- Press the **scan** button (*screen 1* – Page 4) to display the list of sensors available.
Note: The Scan button changes to red and pulses while active.
- If the sensor does not appear on the BLE App Scan list. Perform the double-tap function again.

STEP 5: BLE Setup:

- Select sensor by serial number from list (*screen 1*).
- Screen 2 will pop up for the selected relevant sensor's serial number.
- Review section 1 – Site Prep for hints on sensor mounting preparation and location.
- Click the **install** button on screen 2 to start the installation sequence.

SCREEN 1

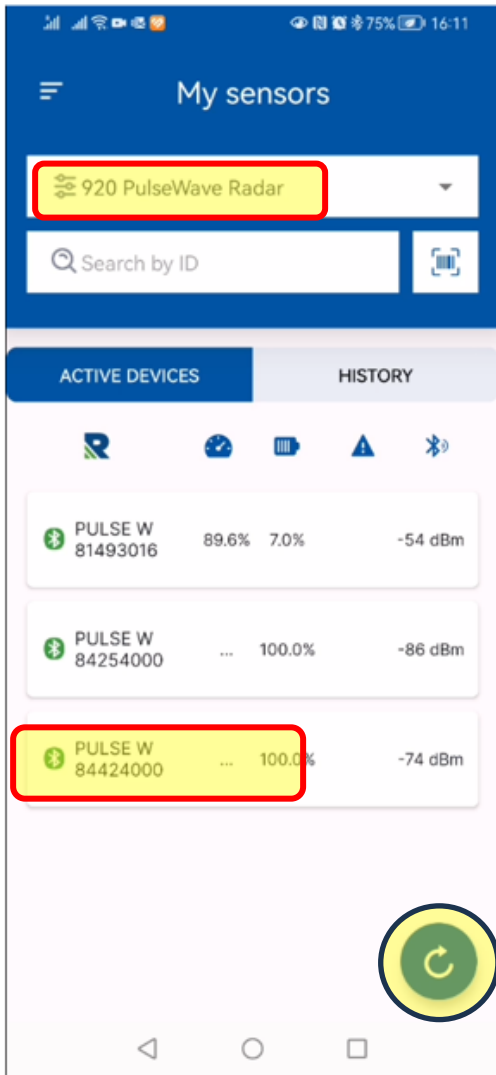

SCREEN 2

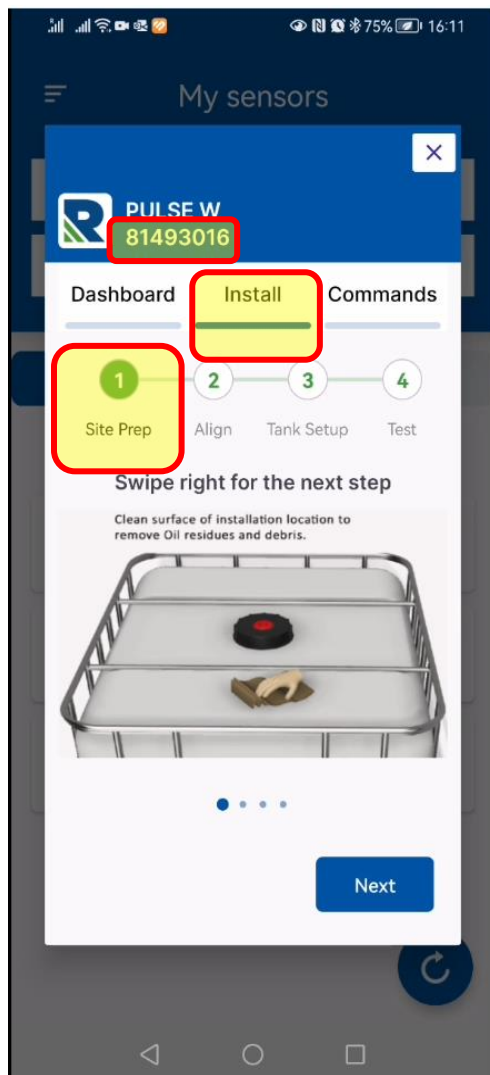

STEP 6: BLE Install - align:

- Press **Next** to move to section 2 – Align.
- If a **green** or **orange** dot is displayed, the sensor is correctly aligned.
- Press **Next** to continue.

- If a **red dot** appears, choose an alternate location that is level.

Note: Red dot indicates that the chosen mounting position is not sufficiently level to give an acceptable performance and the BLE app will not allow the installer to proceed to the next stage.

Note: For tanks heights greater than 2m – it is preferable to have a green dot.

Note: The maximum sensor ullage range is 3m.

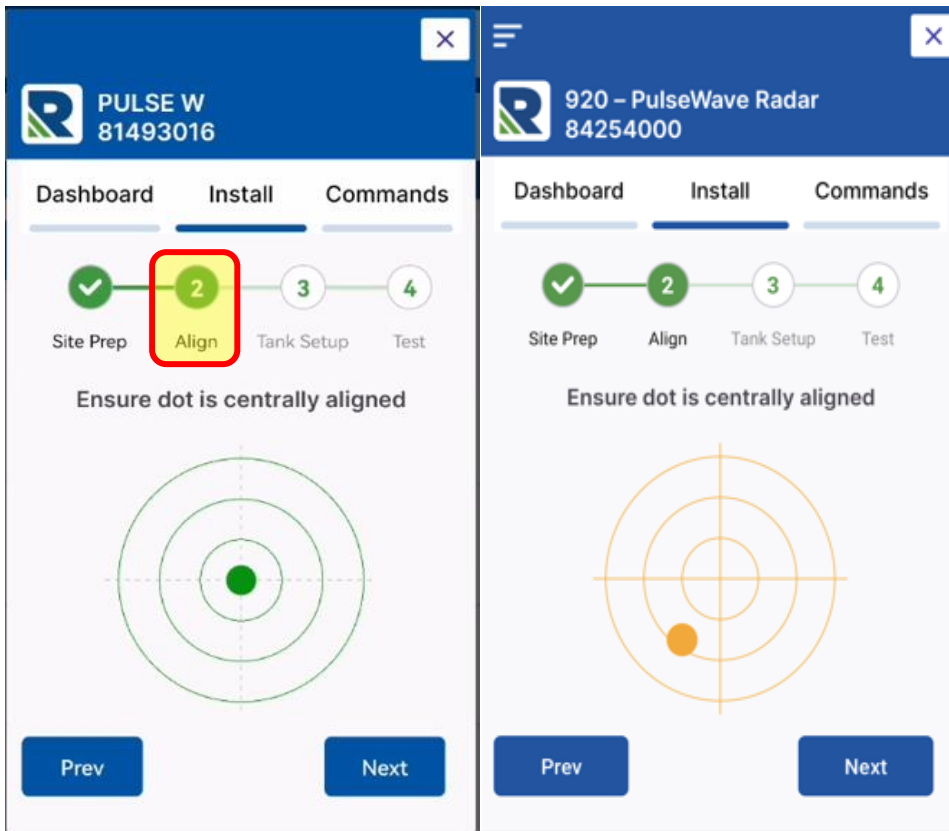

STEP 7: BLE Install - setup:

- Press **Next** to move to **Tank Setup** on section 3.

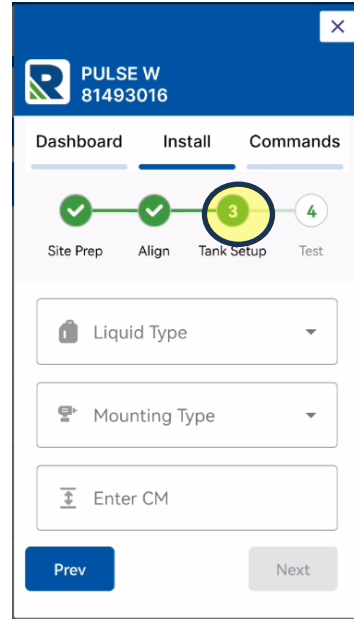
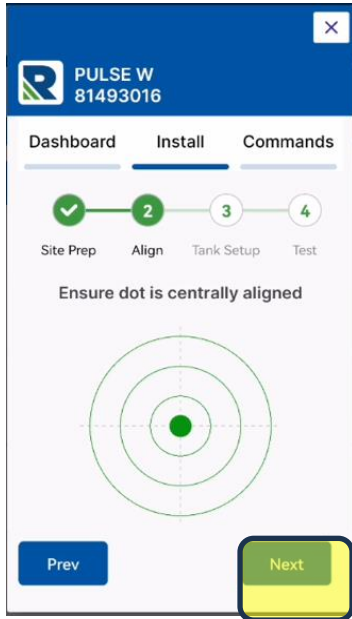

STEP 8: BLE Install - setup:

- On the dropdown menu – select the nearest liquid type: **Oil or Water**
- Select the correct *mounting option*: **Invasive**.
- Enter the usable **tank height in cm**. Refer to appendix for more details.

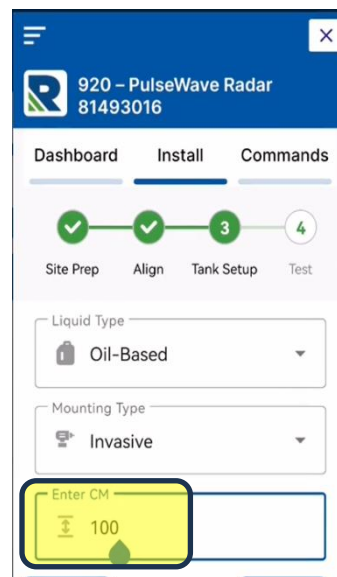
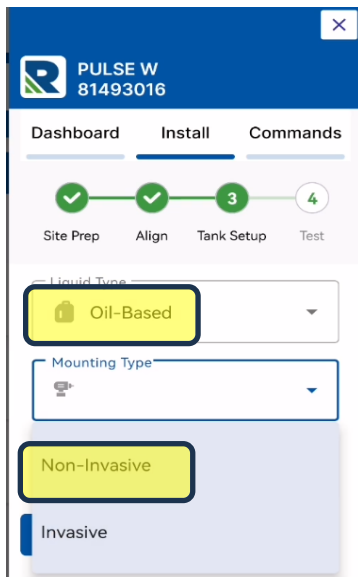

STEP 9: BLE Install - finish:

- Press **Next** to move to section 4 and wait for the test to complete and display **Installation Successful**.
- Press Finish to return to the Dashboard view.

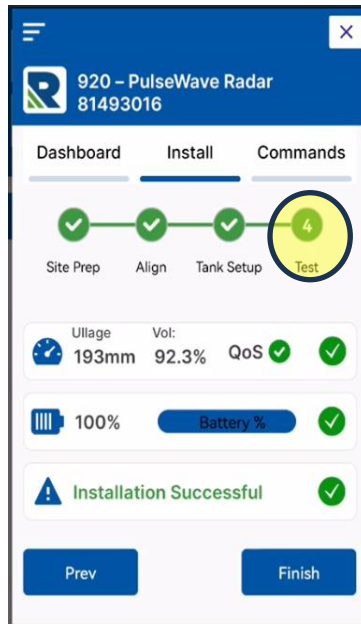

This concludes the installation.

STEP 10: Error in Install

- If the display indicates an **Installation Failed**.
- Check if the liquid type and tank height is correctly set, if not press the **Prev** button to go back and correct them.

In some circumstances the Installation can fail if there are issues with overfilled tanks where the sensor cannot resolve a correct reading in the blind zone. In this case of tank overfilled – it is recommended to either postpone installation or accept the current situation will resolve itself when the liquid level reduces to within the measurable range.

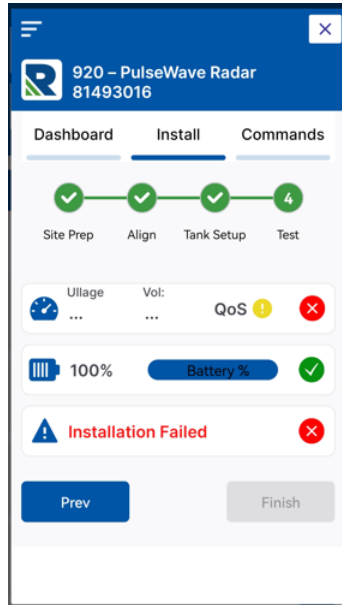

NOTE: Align Failure or obstruction issue:

If during installation with the threaded adapter, it becomes apparent that the sensor fails the alignment test or there is an internal obstruction that causes an issue then there is an alternative invasive installation option detailed below:

- A center hole can be manually drilled in the tank (1" or 25mm).
- The adhesive pad is attached to the base adapter (Refer to the non-invasive adapter mounting for more graphics).
- The bottom adhesive tab is removed and the and the assembly is positioned onto the tank.
- For some applications requiring additional grip, the sensor can also be screwed onto the tank with the four 25mm M4 screws provided.

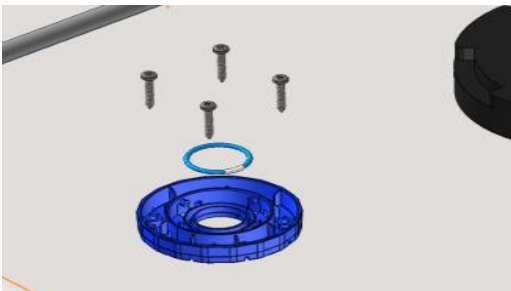

APPENDIX:

WARNING

This sensor is a Class 1 Div 1, Zone 0 intrinsically safe product (ATEX). Please observe the conditions of safe use in the installation site.

NOTE

This sensor is fully sealed and not meant to be repaired or serviced. When the battery life is reached the sensor can be replaced. The battery is non-replaceable.

ALIGNMENT GUIDE.

Please note the installation guide images below.

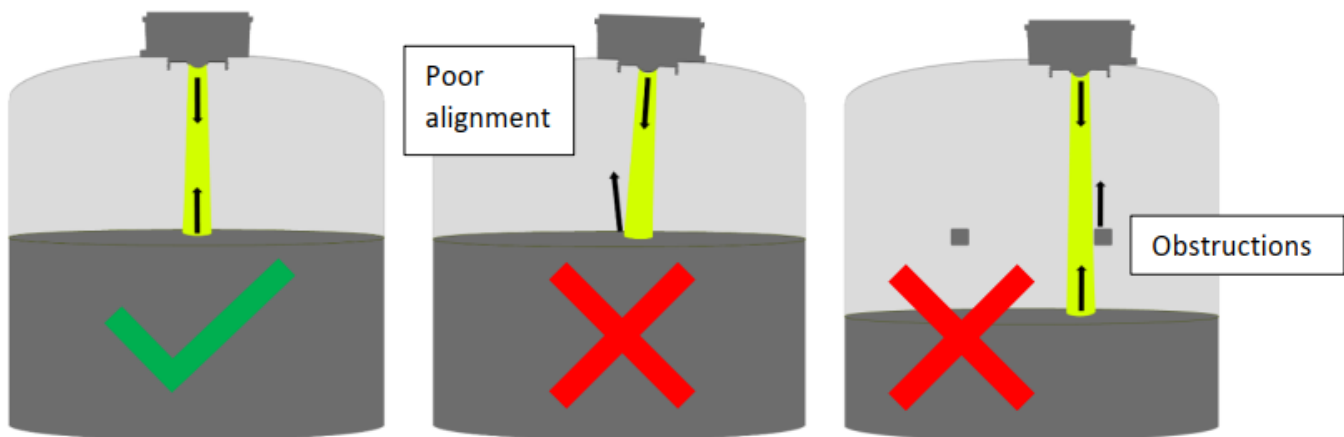

Note: This sensor is a Class 1 Div 1, Zone 0 intrinsically safe product.

Safety Installation Guidelines

WARNING

POTENTIAL ELECTROSTATIC CHARGING HAZARD

Caution must be used when handling or cleaning products so there is no static charge buildup. Do not wipe off the Pulse Wave Sensor with dry cloth. Use only water damp cloth and allow to air dry for cleaning device. Do not use or install in high charge areas. See IEC60079-32-1 for further information.

RISQUE DE CHARGE ÉLECTROSTATIQUE POTENTIEL

Il faut être prudent lors de la manipulation ou du nettoyage des produits afin qu'il n'y ait pas d'accumulation de charge statique. N'essuyez pas le capteur Pulse Wave Sensor avec un chiffon sec. Utilisez uniquement un chiffon humide et laissez sécher à l'air pour nettoyer l'appareil. Ne pas utiliser ou installer dans des zones de charge élevée. Voir IEC 60079-32-1 pour plus d'informations.

Usable Tank Height:



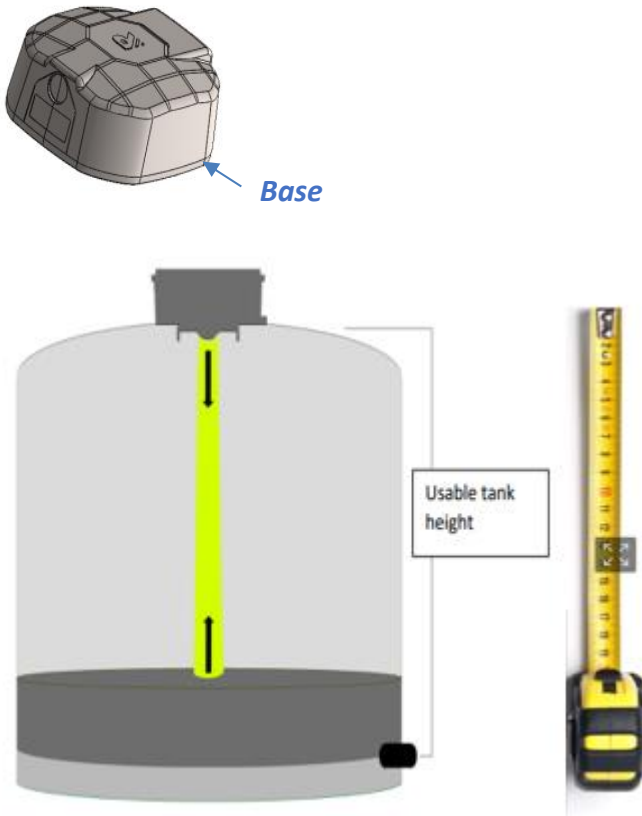











Note: This measurement should range from the base of the sensor to just below the usable minimum level and above the tank bottom.



Cellphone BLE enable (example).



LCD Display Icons:

Component	Icon	Description
Main value		The liquid level in the tank is shown as a percentage value. - Value range: 0-99% - 5% shown as „ 5%“ - „-“ means a no value to display - „-“ means a device in warehouse mode
Battery level		Battery level usage - Value range: 0-99% -  66-100% -  33-66% -  10-33% -  0-10% Notice: Only available on the battery version of the device
Radar Quality of Service		Quality of Service of the radar module. Indicates the conditions in the tank in terms of signal strength and additional interferences. Detailed description in chapter Quality of Service . -  very good conditions -  good conditions -  poor conditions -  critical conditions (measurement uncertain)
Connection status		Visible when communication with another device via Bluetooth is active.
Basic error		Active when a basic error is active. Indicates the possible following problems: - device in warehouse mode - incorrectly device alignment - low battery voltage - short circuit on the voltage cable interface - extreme temperature detected - error RTC
Critical error		Active when critical error occurred. Indicates the device should be replaced.

[Download and install the smartphone app from the links below.](#)

Android



For direct link access click [here](#).

iOS



For direct link access click [here](#).

<https://rochestersensors.com/product/9415-radar-level-sensor/>

Install Manual



IMPORTANT

These instructions are prepared to assist installers and others generally familiar with liquid storage tank equipment. Most consumers are not qualified to perform the installation described herein. If you have any questions concerning installation or operation of this product, contact Rochester Sensors, Inc. or one of our authorized distributors for assistance.

KEY COMMENTS FOR NON-INVASIVE INSTALLATIONS:

Non-invasive mounting (on Plastic / Poly Tank)

✓ Do	✗ Don't
Read the full instructions before starting.	Skip steps or assume you know the process.
Clean the area for mounting	Mount the device on a dirty or contaminated tank surface.
Carefully hand tighten screws on adapter	Over-tighten screws, risking damage. Etc
Chose an invasive mounting option if available	Chose to use fit non-invasive adapter on tank with standing water.

FAQ

- What is maximum range : 3m.
- What is minimum range : 0.15m